

Elemento lineare l.960

Linear element l.960

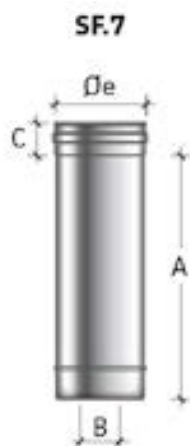

Codice Code	σ	Conf. Pack	€	σ_e	A	B	C
1001-F08	80-130	1		130	960	80	40
1001-F10	100-150	1		150	960	100	40

Elemento lineare l.460

Linear element l.460



Codice Code	σ	Conf. Pack	€	σ_e	A	B	C
1002-F08	80-130	1		130	460	80	40
1002-F10	100-150	1		150	460	100	40

Elemento lineare l.250

Linear element l.250



Codice Code	σ	Conf. Pack	€	σ_e	A	B	C
1003-F08	80-130	1		130	250	80	40
1003-F10	100-150	1		150	250	100	40

Sistema **CAVEDIO INOX-PPS**

INOX-PPS AIR-SHAFT system

Allacciamento caldaia 90°

90° boiler connection

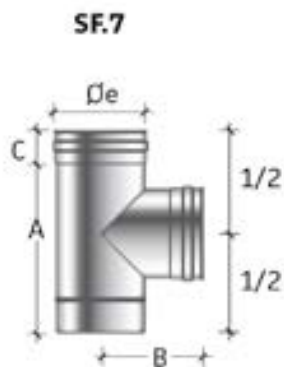

Codice Code	Ø	Conf. Pack	€	Øe	A	B	C
1051-F08	80-130	1		130	280	165	40
1051-F10	100-150	1		150	280	175	40

Allacciamento caldaia 90° uscita MONO-ECO

90° boiler connection with MONO-ECO exit

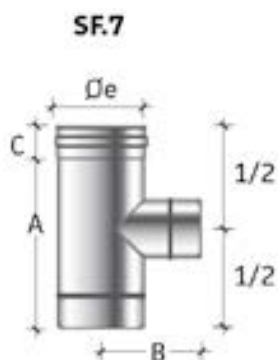

Codice Code	Ø	Conf. Pack	€	Øe	A	B	C
1052-F08	80-130	1		130	200	165	40
1052-F10	100-150	1		150	200	175	40

Elemento presa aria T 90°

90° air intake T element

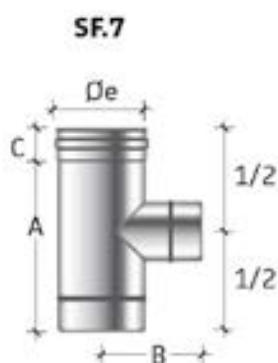

Codice Code	Ø	Conf. Pack	€	Øe	A	B	C
1054-F08	80-130	1		130	200	145	40
1054-F10	100-150	1		150	200	155	40

- I prezzi riportati nel listino sono IVA esclusa - The prices are excluding VAT
- Il prezzo è sempre riferito al singolo elemento - The price is always referred to the single element

Elemento di ispezione con tappo

Inspection element with plug

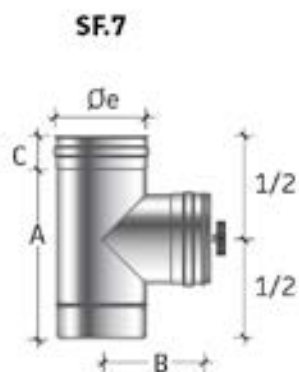

Codice Code	Ø	Conf. Pack	€	Øe	A	B	C
1058-F08	80-130	1		130	200	80	40
1058-F10	100-150	1		150	200	80	40

Curva 45°

45° curve

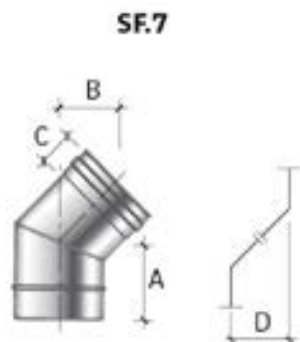

Codice Code	Ø	Conf. Pack	€	Øe	A	B	C	D
1253-F08	80-130	1		130	94	38	40	105
1253-F10	100-150	1		150	101	43	40	115

Curva 90°

90° curve

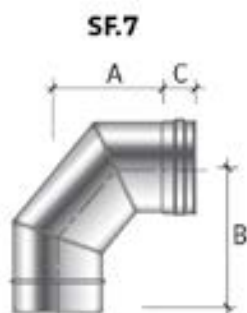

Codice Code	Ø	Conf. Pack	€	Øe	A	B	C
1254-F08	80-130	1		130	95	135	40
1254-F10	100-150	1		150	115	155	40

Sistema CAVEDIO INOX-PPS

INOX-PPS AIR-SHAFT system

Raccogli condensa

Condensate trap

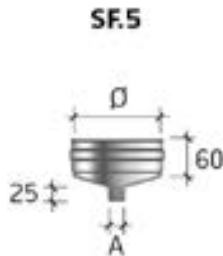

Codice Code	Ø	Conf. Pack	€	A
1201-F08	80-130	1		3/4"
1201-F10	100-150	1		3/4"

Elementi di riduzione

Reduction elements

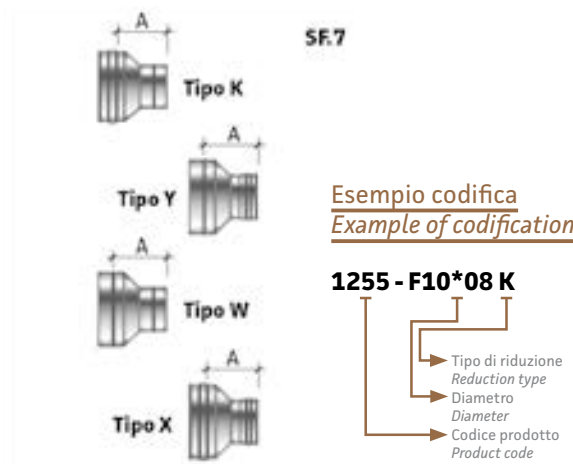

Codice Code	Ø	Conf. Pack	€	Øe	A
1255-F10*08	100-80	1	su richiesta	130	110

Supporto a muro 50÷80 mm

50÷80 mm wall mount



Codice Code	Ø	Conf. Pack	€	Øe	A	B
2108-A08	80-130	1		130	280	300
2108-A10	100-150	1		150	310	330

- I prezzi riportati nel listino sono IVA esclusa - The prices are excluding VAT
- Il prezzo è sempre riferito al singolo elemento - The price is always referred to the single element

Staffa a muro regolabile

Adjustable wall stirrup



Codice <i>Code</i>	\varnothing_e	Conf. <i>Pack</i>	€
1351-C08	130	1	
1351-C10	150	1	

Staffa con tassello

Fixing collar



Codice <i>Code</i>	\varnothing_e	Conf. <i>Pack</i>	€
1357-13	130	1	
1357-15	150	1	

Terminale parapigioggia semplice

Simple raincover chimney



Codice <i>Code</i>	\varnothing	Conf. <i>Pack</i>	€	\varnothing_e	A	B
2401-A08	80-130	1		130	185	240
2401-A10	100-150	1		150	185	250

Chiusura come doppia parete
Closing same double wall

Sistema **CAVEDIO INOX-PPS**

INOX-PPS AIR-SHAFT system

Terminale conico

Truncated cone chimney

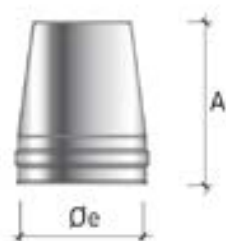

Chiusura come doppia parete
Closing same double wall

Codice <i>Code</i>	Ø	Conf. <i>Pack</i>	€	Øe	A
2403-A08	80-130	1		130	180
2403-A10	100-150	1		150	190

Terminale antivento

Windproof chimney

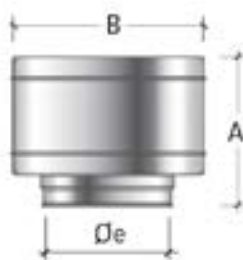

Chiusura come doppia parete
Closing same double wall

Codice <i>Code</i>	Ø	Conf. <i>Pack</i>	€	Øe	A	B
2405-A08	80-130	1		130	230	230
2405-A10	100-150	1		150	250	250

Terminale "Eolo"

"Eolo" chimney

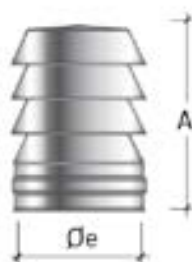

Aspirazione e scarico dal terminale
Intake and exhaust from the chimney

Codice <i>Code</i>	Ø	Conf. <i>Pack</i>	€	Øe	A
1404-C08	80-130	1		130	290
1404-C10	100-150	1		150	290

- I prezzi riportati nel listino sono IVA esclusa - The prices are excluding VAT
- Il prezzo è sempre riferito al singolo elemento - The price is always referred to the single element

Terminale coassiale

Coaxial chimney



Aspirazione e scarico dal terminale
Intake and exhaust from the chimney

Codice Code	Ø	Conf. Pack	€	Øe	A
1406-C08	80-130	1		130	290
1406-C10	100-150	1		150	290